

# LD LOW PRESSURE DIAPHRAGM

*The Cost Effective Simplicity  
and Safety of a Pneumatic  
Metering Pump Design*



*All 316 SS Construction*

*PTFE Wetted Parts*

DISTRIBUIDOR AUTORIZADO

**NOVATEC**  
FLUID SYSTEM S.A.

+57 316 4782755

CALI, COLOMBIA: Tel. (60-2) 418 4006  
Cl. 69 # 7D-Bis 15 (ZIP: 76001101)

[novatecfs.com](http://novatecfs.com)



**WILLIAMS**<sup>®</sup>  
CHEMICAL METERING PUMPS

# LD LOW PRESSURE DIAPHRAGM

S E R I E S   O F   M E T E R I N G   P U M P S

## SIMPLICITY IN DESIGN, OPERATION AND MAINTENANCE

### FEATURES:

- Simple Design
- Easy to Maintain
- Intrinsic Safety of Pneumatic Operation
- Stroke Length and Stroke Rate Adjustment
- High Flow Turndown
- Corrosion Resistant Construction
- All 316 SS or PTFE Wetted Parts
- Ease of Installation
- Recommended for discharge pressures below 120 PSI

### STANDARD MATERIALS:

- Wetted Parts - 316SS or PTFE
- Pneumatic Section - 316SS
- Diaphragm - PTFE
- Controller - 316SS
- Relays - 316SS

### DESIGN IMPROVEMENTS:

- Higher Flow Rates than PD Series pump models.
- All PTFE diaphragms for all pump sizes.
- PTFE-coated O-rings in contact with process fluid.
- FKM O-rings in contact with air/gas supply.
- Stroke Adjuster locks in place with a simple thumbscrew.
- Stroke Adjuster scale easier to read and set than previous diaphragm pump models.
- Check Valves for 316SS models have PTFE soft seats with 316SS balls. (LD200 & 400)
- Check Valves for PTFE models have PTFE soft seats with Ceramic balls. (LD200 & 400)
- Check Valves on LD100 models are PVDF with PVDF soft seats and Ceramic or Ruby Sapphire balls.

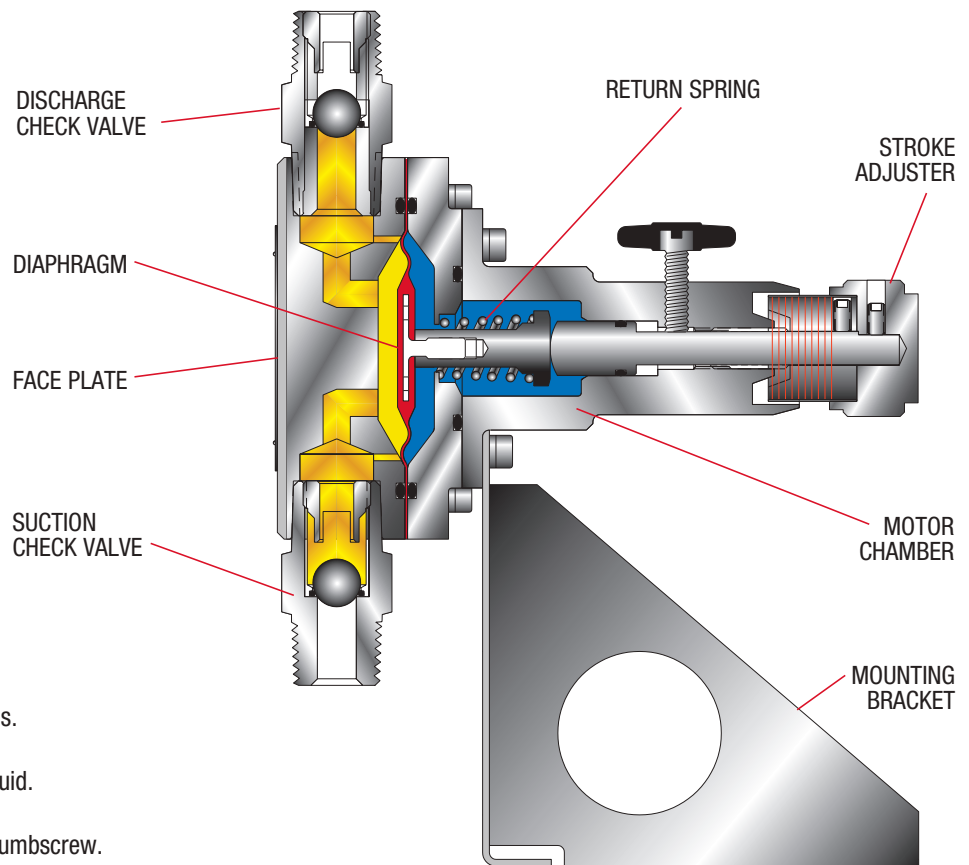

## OPERATING CYCLE

**POWER STROKE:** As the air or gas enters the MOTOR CHAMBER from the controller, the DIAPHRAGM is driven into the fluid cavity of the FACEPLATE, displacing the fluid in the FACEPLATE and extending the RETURN SPRING. As the fluid is displaced, the rise in pressure closes the SUCTION CHECK VALVE and opens the DISCHARGE CHECK VALVE. A precise amount of fluid corresponding to the stroke of the DIAPHRAGM is discharged.

**SUCTION STROKE:** When the air or gas pressure is exhausted from the MOTOR CHAMBER, the RETURN SPRING assists the DIAPHRAGM in returning to its static position. The retraction of the DIAPHRAGM reduces the pressure in the fluid cavity, thus closing the DISCHARGE CHECK VALVE and opening the SUCTION CHECK VALVE. The fluid cavity is again filled, preparing the pump for another power stroke.

## PERFORMANCE SPECIFICATIONS

Models	Diaphragm Size (Inch)	Maximum Volume GPH / LPH		Maximum Discharge Pressure *		Air to Fluid Pressure	Strokes Per Minute (SPM)	Volume Per Stroke (cc)	Standard Diaphragm Material (STD)	Maximum Air Supply		Max. Air Usage At Max. Volume		Approx. Shipping Weight	
		Simplex	PSI	Bar	PSI					Bar	SCF/D	SCM/D	Lbs.	Kg.	
															PSI
CLD100-316-TFE	1	0.75 / 2.8	80	5.52	100.80	1-45	1.0	TFE	100	6.9	20	0.64	7.0	3.1	
CLD200-316-TFE	2	10.0 / 37.8	98	6.76	100.98	1-45	14.0	TFE	100	6.9	255	5.78	9.12	4.1	
CLD400-316-TFE	4	45.0 / 170.3	93	6.41	100.93	1-45	63.0	TFE	100	6.9	1200	27.30	17.25	7.8	
CLD100-TFE-TFE	1	0.75 / 2.8	75	5.17	100.75	1-45	1.0	TFE	100	6.9	20	0.64	6.0	2.7	
CLD200-TFE-TFE	2	10.0 / 37.8	93	6.41	100.93	1-45	14.0	TFE	100	6.9	255	5.78	7.25	3.2	
CLD400-TFE-TFE	4	45.0 / 170.3	90	6.20	100.90	1-45	63.0	TFE	100	6.9	1200	27.30	11.5	5.2	

NOTE: \* with 100 PSI Air Supply Max

### VISCOSITY

Maximum recommended viscosity **1280 CP** (Centipoise) or **6000 SSU** (Saybolt Seconds Universal).

### OPERATING TEMPERATURE

The recommended operating temperature of the pumps with the corresponding faceplate and standard diaphragm material is as follows:

316 SS: +40°F (+4°C) to 185°F (85°C)  
 PTFE: +40°F (+4°C) to 185°F (85°C)

For temperatures beyond these limits, please consult the factory.

### STATIC SUCTION LIFT: (Inches of Water)

The maximum volume of the pumps is reduced under a suction lift condition. The maximum suction lift capability for each pump is 60 inches (with the footvalve on the tank end of a rigid suction line).

### MAX FLOW RATE AT 60" LIFT WITH FOOT VALVE:

LD100-PTFE-PTFE 0.7 GPH (2.6 LPH)  
 LD200-PTFE-PTFE 9.7 GPH (36.7 LPH)  
 LD400-PTFE-PTFE 45.0 GPH (170.3 LPH)

### PART NUMBERING SYSTEM

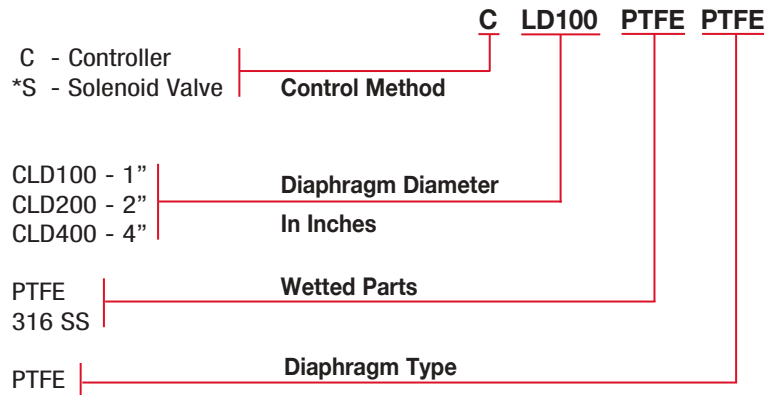

**For Duplexed Pumps: Consult Factory**

**Note: When choosing the solenoid option, you must specify the voltage and cycle rate required, ie. (120 VAC/60 Hz).**

**\* Old style diaphragms**

## DIMENSIONS

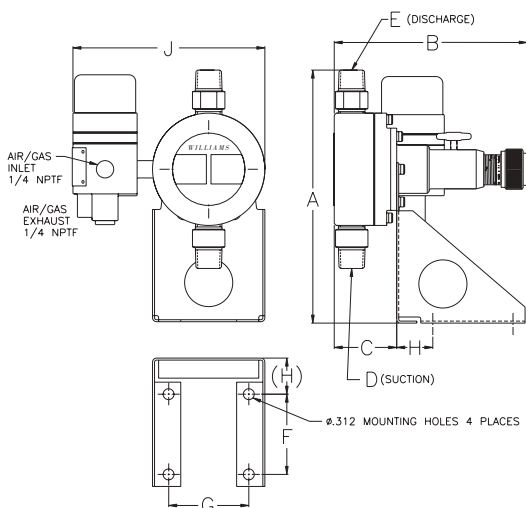

MODEL	A		B		C		D	E	F		G		H		J	
	inches	mm	inches	mm	inches	mm			inches	mm	inches	mm	inches	mm	inches	mm
CLD100-TFE	7.10	180.34	5.88	149.35	1.66	42.16	1/4"NPTM	1/4"NPTM	2.50	63.50	2.50	63.50	1.13	28.70	5.53	140.46
CLD100-316	7.35	186.69	5.72	145.29	1.52	38.61	1/4"NPTM	1/4"NPTM	2.50	63.50	2.50	63.50	1.13	28.70	5.53	140.46
CLD200-TFE	7.75	196.85	6.45	163.83	1.25	31.75	1/2" NPTM	1/2" NPTM	2.50	63.50	2.50	63.50	1.13	28.70	6.10	154.94
CLD200-316	7.85	199.39	6.12	155.45	1.90	48.26	1/2" NPTM	1/2" NPTM	2.50	63.50	2.50	63.50	1.13	28.70	6.10	154.94
CLD400-TFE	10.32	262.13	8.32	211.33	2.72	69.09	3/4" NPTM	3/4" NPTM	3.88	98.55	2.50	63.50	1.50	38.10	8.00	203.20
CLD400-316	10.60	269.24	8.12	206.25	2.45	62.23	3/4" NPTM	3/4" NPTM	3.88	98.55	2.50	63.50	1.50	38.10	8.00	203.20





**PERFORMANCE**

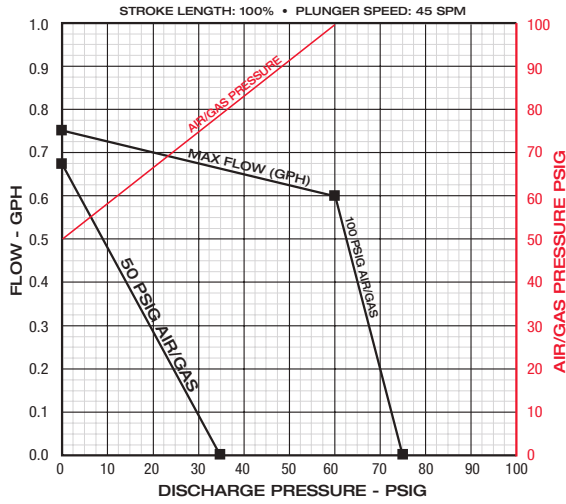

**CLD100-TFE-TFE**

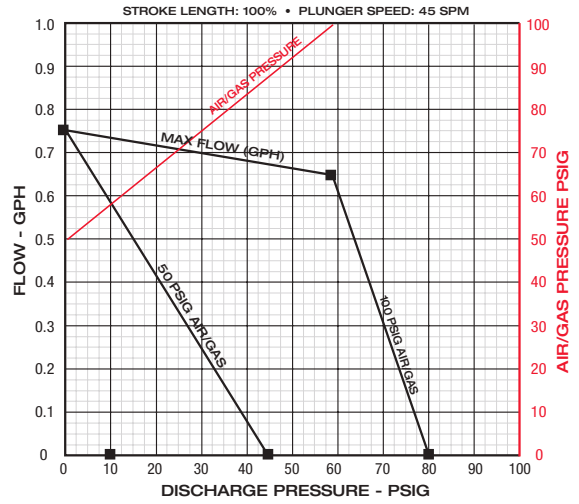

**CLD100-316-TFE**

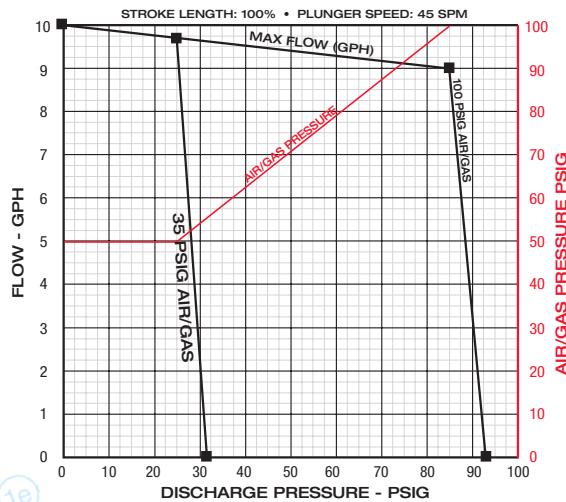

**CLD200-TFE-TFE**

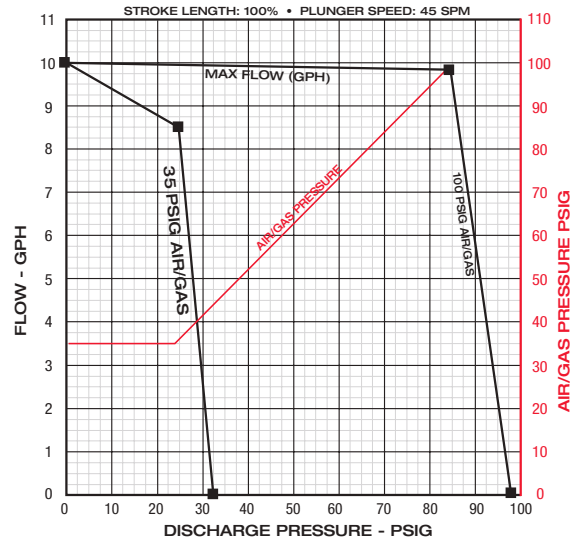

**CLD200-316-TFE**

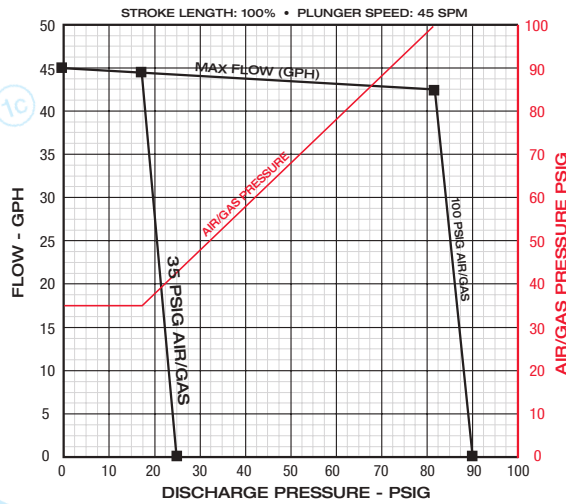

**CLD400-TFE-TFE**

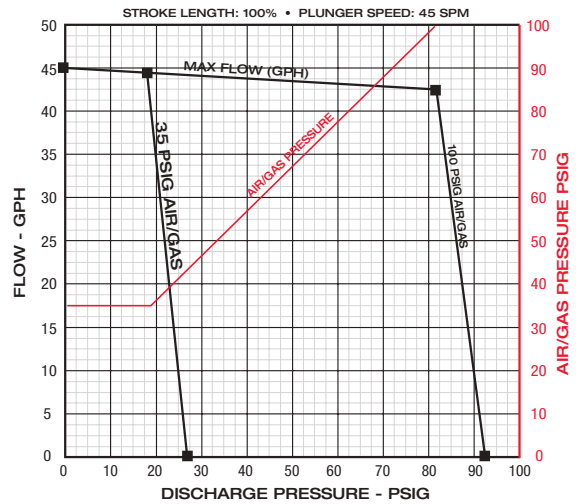

**CLD400-316-TFE**

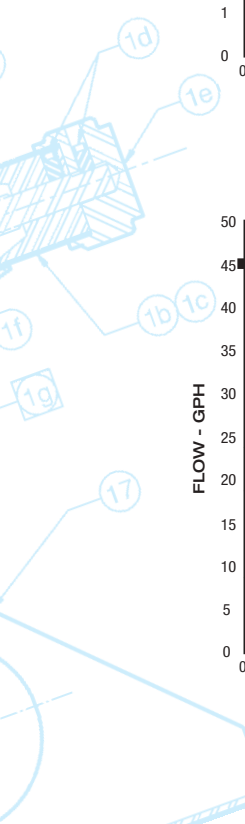

## CONTROL METHODS FOR THE PUMP

### MK XIIA OSCILLAMATIC® CONTROLLER

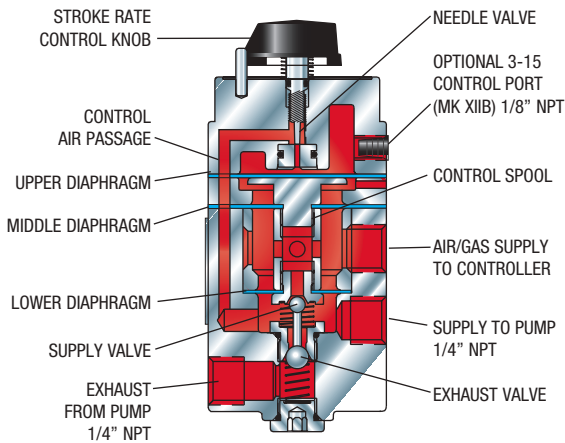

The MK XIIA Controller operates on the same operating principal as the MK X Controller. The MK XIIA has the same upper and lower chambers, but are separated with flexible diaphragms rather than sliding seals. A capillary tube, controlled by a needle valve, transfers the air/gas supply to the pump from the lower to the upper chamber.

When the spool is in the highest position, a pilot plug closes a vent and opens the supply air/gas to the pump. When the spool is in its lowest position, the pilot plug prevents the supply air/gas from entering the pump, and opens the air/gas vent to let it exhaust the pump. The spool then returns to its highest position to repeat the process.

### CONTROLLER-PNEUMATIC RELAY COMBINATION FOR DUPLEXING

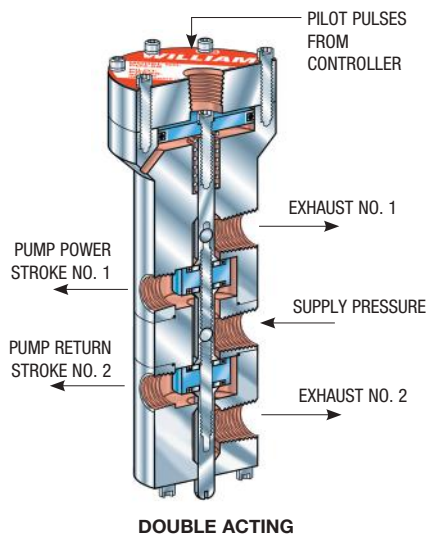

The PNEUMATIC RELAY is a pilot-operated valve designed to provide the higher air or gas flow rates necessary for higher pressures from 100 to 150 psi. The PNEUMATIC RELAY is actuated by the pulses produced by the OSCILLAMATIC® CONTROLLER.

#### TYPICAL INSTALLATION FOR DUPLEXED PUMPS

Includes:  
 1 Controller    2 Pumps  
 1 Relay        1 Manifold

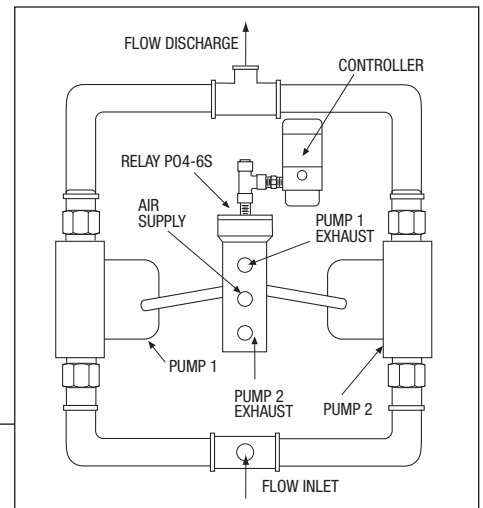

### TYPICAL INSTALLATION

#### SOLENOID VALVES

The pumps can be automated by replacing the CONTROLLER with a 3-way electro-pneumatic SOLENOID VALVE. The SOLENOID VALVE can be cycled in order to achieve the desired pump output. Flow tracking can be accomplished by having a FLOWMETER or PH METER signal interpreted by our WPC9001 or a PLC.

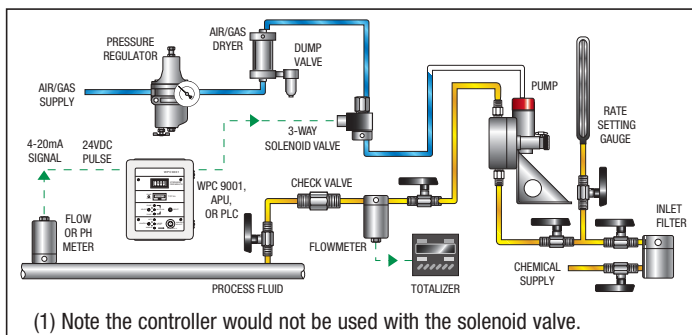

Flow Tracking Controller Configuration

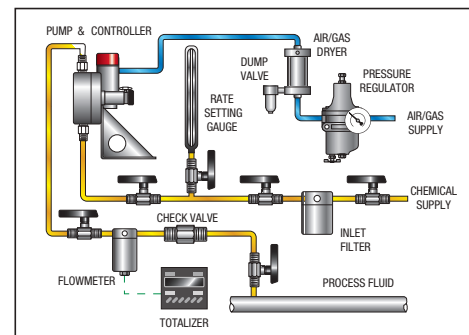

Standard Pneumatic Controller Configuration

## PUMP ACCESSORIES



DRUM GAUGES Liquid Level/Injection Rate Gauge	
MODELS	MATERIALS
C779WS	Carbon Steel
C779WS-V	Carbon Steel - Vented
C779WS/SS	Stainless Steel
C779WS/SS-V	Stainless Steel - Vented
30216-CS-V-GPD-S	Carbon Steel
30216-S6-V-GPD-S	Stainless Steel

AUTOMATIC DUMP VALVES Used with the Air or Gas Dryer-Filters		
MODELS	BOWL	MAX. PRESSURE
ADV-150-A	Plastic	150 PSI
ADV-250-A	Steel	250 PSI



PCV125 AL Pressure Regulator		
SENSITIVITY	FLOW RATES	MAX. PRESSURE
0.1 PSI	20SCFM	250 PSI
0.689kPa	.566m3/min	1724 kPa



LIQUID CHEMICAL FILTERS 316 Stainless Steel		
MODELS	CONNECTION FILTER ELEMENT	OPTIONAL FILTER ELEMENT
LCF10-25	1/4" NPT 25 micron, Std	1, 2, 8 microns or 100 mesh stainless steel screen
LCF15-25	1/2" NPT 25 micron, Std	

AIR OR GAS DRYER-FILTERS Complete with Manual Drain Valve		
MODELS	FLOW RATES	MAX. PRESSURE
J150	40SCFM	150 PSI
J500	40SCFM	500 PSI



APU-XP Automatic Processing Unit	
FREQUENCY	ACCURACY
0-45 SPM	± 0.25% of span

WPC9001 Electronic Pump Controller			
MODEL	NEMA CLASS	MAX. TEMP.	OPERATING MODES
WPC9001-GP	4X	140° F	Auto
WPC9001-XP	7	60° C	Manual Switching



Committed to Delivering Fluid Metering Products, Services & Technology of the Highest Quality, and to Always Exceed Our Customer's Expectations.

Milton Roy Company • 201 Ivyland Road • Ivyland, PA 18974 USA • (800) 235-3421 • (215) 293-0415 • Fax: (215) 293-0498 • E-mail: info@williamspumps.com

[www.williamspumps.com](http://www.williamspumps.com)