

V **DUAL SEAL PLUNGER**

S E R I E S O F M E T E R I N G P U M P S

Committed to Delivering Fluid Metering Products, Services & Technology of the Highest Quality, and To Always Exceed Our Customer's Expectations.

- **PNEUMATIC OPERATION**
- **HIGH FLOW TURNDOWN**
- **INTRINSICALLY SAFE**
- **GREATER RELIABILITY**



- **CORROSION RESISTANT**
- **SIMPLE MAINTENANCE**
- **EASE OF INSTALLATION**
- **REPLACES OUR W&D SERIES PUMP**



WILLIAMS
INSTRUMENT INCORPORATED

MILTON ROY
A Sundstrand Company

**MEETS API 675
REQUIREMENTS**

V DUAL SEAL PLUNGER

SERIES OF METERING PUMPS

SIMPLICITY IN DESIGN, OPERATION AND MAINTENANCE

PUMP FEATURES:

- ① Stroke Adjuster is made more compact and adjustment is simplified with an internally threaded design. The positive locking device to hold stroke length is readily accessible and easy to operate.
- ② The Pneumatic Piston and Fluid Plunger Assembly is guided at both ends on TFE composite bearings ensuring concentric movement of the plunger through the seals.
- ③ The clearance between the return spring and plunger has been optimized to eliminate any possible contact.
- ④ A true double sealing arrangement is used so that secondary seal containment is provided.
- ⑤ Lubrication has been simplified with the use of synthetic grease. The lubrication chamber is filled once over the life of the seals.
- ⑥ The bleeder is equipped with a barbed fitting for plastic tubing so that the fluid bled from the fluid chamber can be collected.
- ⑦ Both the discharge and suction check valves have tough TFE composite seats for long life and positive sealing.
- ⑧ Threaded port after the secondary seal provides for the indication, collection or containment of any seal leakage.

MATERIALS:

Wetted Parts: 316 SS

Check Valves:

Body/Retainer/Ball: 316 SS

Spring: Elgiloy

Seat: TFE

Plunger: As specified

Bleeder: 316 SS

Seals: As specified

Pneumatic Section:

Motor Cylinder Face Plate: 316 SS (V Model)

Anodized Aluminum (X Model)

Piston: Anodized Aluminum

Piston Seal: Buna N

Return Spring: 17-7ph

Controller - MK XII: 316 SS (V Model)

Anodized Aluminum (X Model)

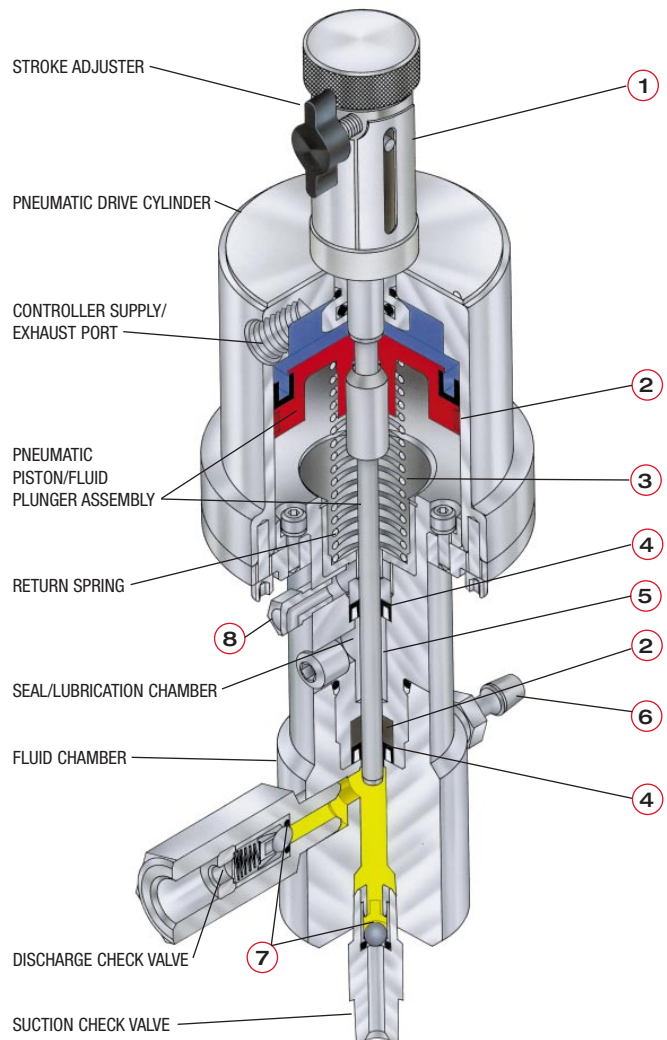

OPERATING CYCLE

POWER STROKE: As the CONTROLLER air or gas enters the PNEUMATIC DRIVE CYLINDER, the PISTON-PLUNGER ASSEMBLY is driven down into the FLUID CHAMBER, displacing fluid and compressing the RETURN SPRING. As the plunger displaces the fluid, the rise in pressure closes the SUCTION CHECK VALVE and opens the DISCHARGE CHECK VALVE. A precise amount of fluid, corresponding to the stroke of the plunger, is discharged.

SUCTION STROKE: When the air or gas is exhausted from the PNEUMATIC DRIVE CYLINDER the RETURN SPRING forces the PISTON-PLUNGER ASSEMBLY to return to its original position. The drop in pressure in the FLUID CHAMBER caused by the retraction of the piston allows the spring loaded DISCHARGE CHECK VALVE to close and the SUCTION CHECK VALVE to open so that the FLUID CHAMBER is again filled and ready for the power stroke.

PERFORMANCE SPECIFICATIONS *

MODEL @ AIR/GAS SUPPLY PRESSURE	MAX VOLUME GPH/LPH	VOLUME PER STROKE CC	STROKE LENGTH INCH	STROKES PER MINUTE (RANGE)	MAX DISCHARGE PRESSURE PSIG / BARG	MAX AIR CONSUMPTION			
						100 PSIG SCF PER DAY	6.9 BAR SCM PER DAY	150 PSIG SCF PER DAY	10.3 BAR SCM PER DAY
CP125V125 @ 100 PSI/6.9 BAR	.07 / .27	.1	.5	1-45	8650 / 596.4	180	5		
CP250V225 @ 100 PSI/6.9 BAR	.57 / 2.16	.8	1	1-45	7200 / 496.4	1150	32		
CP250V300 @ 100 PSI/6.9 BAR	.57 / 2.16	.8	1	1-45	13,100 / 903.2	2100	59		
CP500V225 @ 100 PSI/6.9 BAR	2.30 / 8.71	3.2	1	1-45	1750 / 120.7	1150	32		
CP500V300 @ 100 PSI/6.9 BAR	2.30 / 8.71	3.2	1	1-45	3250 / 224.1	2100	59		
CRP500V400 @ 100 PSI/6.9 BAR @ 150 PSI/10.3 BAR	2.30 / 8.71 2.30 / 8.71	3.2 3.2	1 1	1-45 1-45	6300 / 434.4 9200 / 634.3	3584	101	5250	149
CRP750V400 @ 100 PSI/6.9 BAR @ 150 PSI/10.3 BAR	5.00 / 18.9 5.00 / 18.9	7.0 7.0	1 1	1-45 1-45	2600 / 178.3 4000 / 275.8	3584	101	5250	149
CRP1000V400 @ 100 PSI/6.9 BAR @ 150 PSI/10.3 BAR	9.08 / 34.37 9.08 / 34.37	12.7 12.7	1 1	1-45 1-45	1520 / 104.8 2300 / 158.6	3584	101	5250	149
CRP1000V600 @ 100 PSI/6.9 BAR @ 150 PSI/10.3 BAR	9.04 / 34.22 7.00 / 26.50	12.6 9.8	1 1	1-45 1-35	3400 / 234.4 4700 / 324.0	7190	203	10210	289
CRP1000V800 @ 100 PSI/6.9 BAR @ 150 PSI/10.3 BAR	8.81 / 33.35 6.82 / 25.81	12.3 9.5	1 1	1-45 1-35	6300 / 434.4 9100 / 627.4	12342	349	18150	514

* This data should only be used to provide you with your initial size selection. You must refer to the actual performance graphs on pages 6 and 7 in order to verify your pump selection.

PLUNGER PUMP SELECTION GUIDELINES

PLEASE NOTE THAT OUR PLUNGER PUMPS HAVE PRESSURE-ACTIVATED SEALS. THEY SHOULD NOT BE USED AT PRESSURES BELOW 100 PSI.

STROKE RATE AND LENGTH

Even though the pumps are designed to operate over their entire stroke rate and length ranges, we suggest that you take into consideration your future flow requirements. Rather than operating at the flow extremes you may wish to use the next pump size larger or smaller.

FILTRATION

Plunger pumps are susceptible to contamination. Therefore we recommend a 25 micron filter in the suction line of the pump.

SUCTION CONDITIONS

The V Series plunger pumps are designed for flooded suction only. They are NOT recommended for a suction lift condition. The recommended pressure at the suction inlet is:

1 ft. (.3 meters) min. • 10 ft. (3 meters) max.

NOTE: The normal cracking pressure of the discharge check valve is 90 PSI.

VISCOSITY

The maximum recommended viscosity is 4500 SSU (Saybolt Seconds Universal) or 960 CP (Centipoise).

FLOW TURNDOWN RATIO: 100:1

NOTE: The flow turndown ratio is defined as the total flow range of the pump, which includes both speed and stroke length adjustments.

ACCURACY

± 0.5% with Solenoid Valve and WPC-9001

± 1.5% with MK-XII Controller

TEMPERATURE

The seals are the limiting factor. Please refer to the seal selection guide for temperature limits.

AIR/GAS SUPPLY

The air/gas supply must always be regulated since fluctuating pressures will affect speed and accuracy. The air/gas must be free from particulate and we recommend dry air/gas for trouble free operation.

PUMP SETTING GAUGE

We recommend the use of a pump setting gauge as a simple method of adjusting the flow of the pump.

DISCHARGE LINE CHECK VALVE

It is good design practice to install a check valve in the pump discharge line at the point it enters the process line. This will prevent the process fluid from reaching the pump.

USING THE GRAPHS*

A) Use The Following Performance Flow Curves* in Order To:

1) Determine the flow capability of the pump you have selected.

If you have sized the pump too close to the upper or lower stroke rate limit, you may wish to change to a different pump size. Of course you can also change your flow for a given stroke rate by adjusting the stroke length. Example:

These Settings Will Produce The Same Pump Flow Rate	
STROKE RATE	STROKE LENGTH
10	1" (100%)
20	1/2" (50%)
40	1/4" (25%)

2) Determine the air pressure necessary to provide the desired pump discharge pressure.

- B) The flow curves show the maximum flow/pressure limit of the pumps. The upper near horizontal line represents the maximum flow capability (45 SPM @ 100% stroke). The near vertical lines represent the maximum discharge pressure at the corresponding air/gas pressure. The area under the curve represents the entire flow/pressure range for the pumps.
- C) As you can see, the flow rate changes with discharge pressure. In order to determine the stroke rate or stroke length for your particular application use the following procedure:

Step 1: First use the performance table on page 4 to make your 'initial' selection. Make certain the pump selected satisfies your maximum flow and pressure requirements.

Step 2: Establish the volume per stroke (cc/ stroke) for your discharge pressure by drawing a vertical line from your discharge pressure found on the horizontal axis until it intersects the maximum flow curve line. This point represents the maximum flow at your discharge pressure. Read the value on the left. Multiply this number by 3785 cc/gallon. Then divide by 60 min./hr and then 45 strokes/min. The resultant is the maximum cc/stroke at your discharge pressure.

Step 3: Next, convert your actual flow rate into cc/min (ref. 1 gallon = 3785 cc). Now, divide this number by the answer in step 2 (cc/stroke) in order to get strokes per minute. Your answer is the stroke rate of the initial pump you selected, when the stroke length is set at 100%. If this value is close to the extremes (1-45 or 1-35 SPM) you may wish to select the next smaller or larger pump, in order to allow for a change in the future flow rate.

Example:

Application: 1 gallon per day @ 3000 psi

Step 1: 1 gallon per day ÷ 24 hr/day = .042 gallons/hr
selection from table on page 4 is a CP125V125

Step 2: Follow 3000 psig up to max flow curve and read over on the left axis. The answer is .054 gph.

$$.054 \frac{\text{gallons}}{\text{hr}} \times \frac{3785 \text{ cc}}{\text{gallon}} \times \frac{1 \text{ hr}}{60 \text{ min}} \times \frac{1 \text{ min}}{45 \text{ stroke}} = .075 \frac{\text{cc}}{\text{stroke}}$$

*Metric flow performance curves are available on request.

Step 3: From step 1 convert your actual flow to cc/min.

$$1 \frac{\text{gallon}}{\text{day}} \times \frac{3785 \text{ cc}}{\text{gallon}} \times \frac{1 \text{ day}}{24 \text{ hrs}} \times \frac{1 \text{ hr}}{60 \text{ min}} = 2.628 \frac{\text{cc}}{\text{min}}$$

Now divide 2.6 cc/min by the answer in step 2.

$$2.6 \frac{\text{cc}}{\text{min}} \times \frac{1 \text{ stroke}}{.075 \text{ cc}} = 35 \frac{\text{strokes}}{\text{min}}$$

In this case you could select the next larger pump from the table on page 4, a CP250V225, which would produce the same flow rate when set at 1/4 the stroke length and run at 13 strokes per minute.

D) THE RED CURVE defines the relationship between air/gas supply pressure and discharge pressure. For each discharge pressure there is a minimum air/gas supply pressure required. Always add 200 PSI to your discharge pressure in order to ensure positive injection. Find the discharge pressure on the horizontal axis and follow it up to the red curve. At that point, read your air/gas pressure requirements on the right axis in PSIG. The minimum air/gas supply pressure will produce discharge pressures found to the left of the 35 PSIG limit line.

In the above example the required air/gas supply pressure can be read off the graph by first adding 200 psi to the 3000 psi discharge pressure. Then locate 3200 psi on the discharge pressure axis and follow it up until it intersects the red line. Now, follow this point to the air/gas supply pressure axis on the right and you will find that 50 psig air/gas pressure is necessary to operate the pump.

Example:

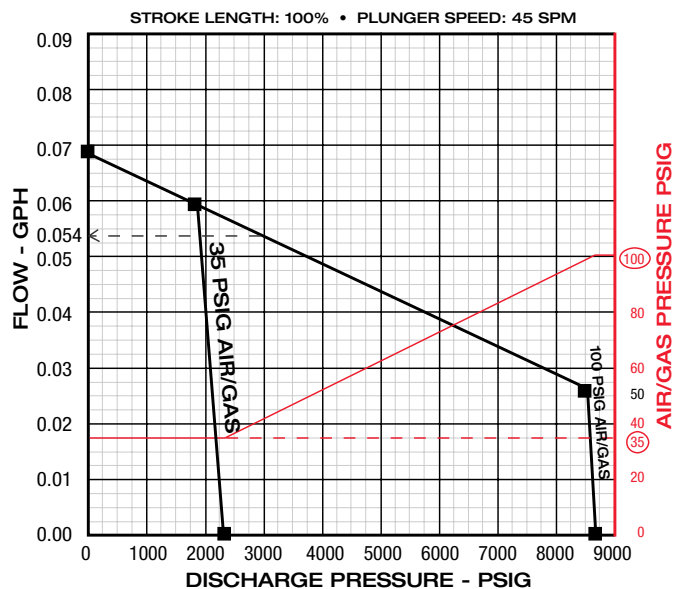

CP125V125

Discharge Pressure PSI	0	500	1000	1900	5000	8500
Volume Per Stroke @ 100% Stroke CC	.097	.093	.089	.083	.060	.036
Air Pressure PSI	35	35	35	35	75	100

PERFORMANCE

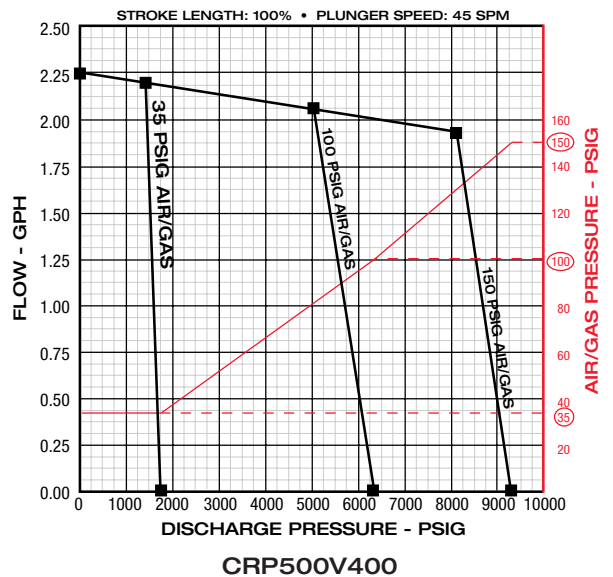
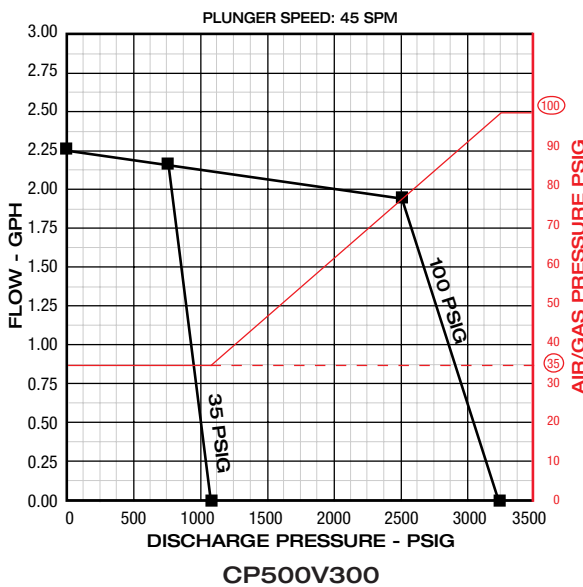
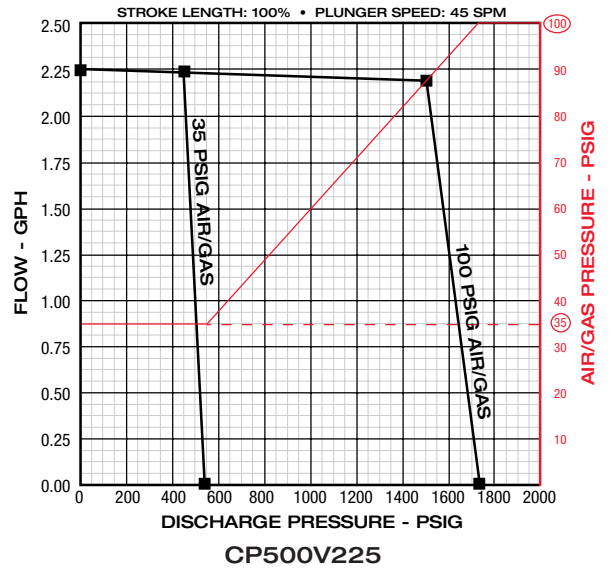
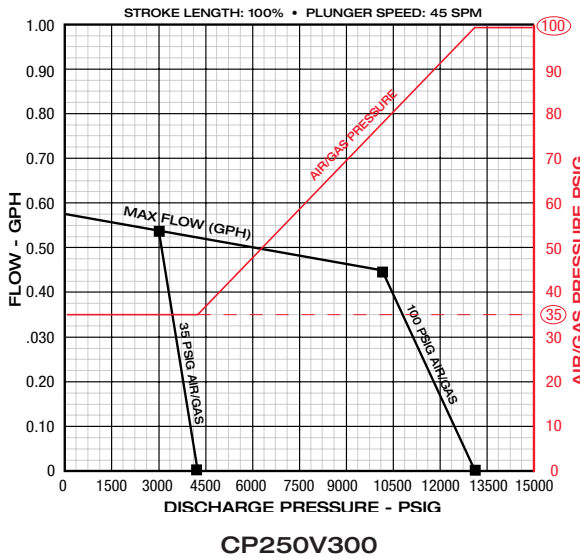
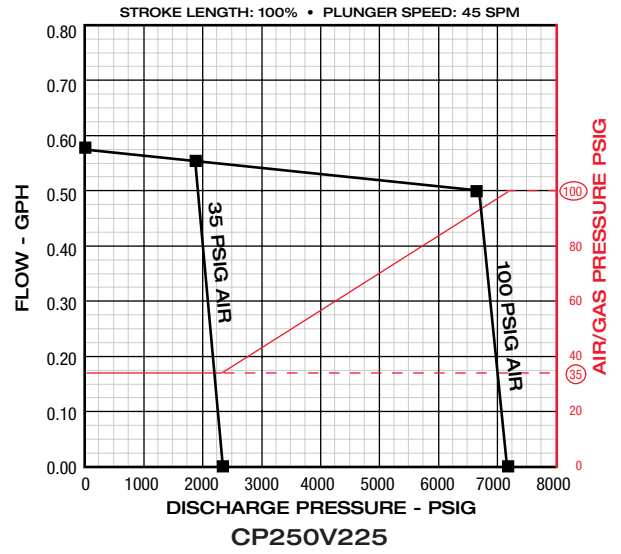
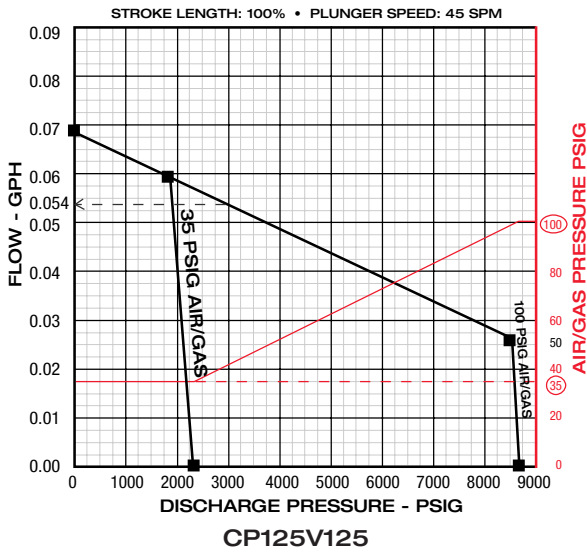

PERFORMANCE (CONT.)

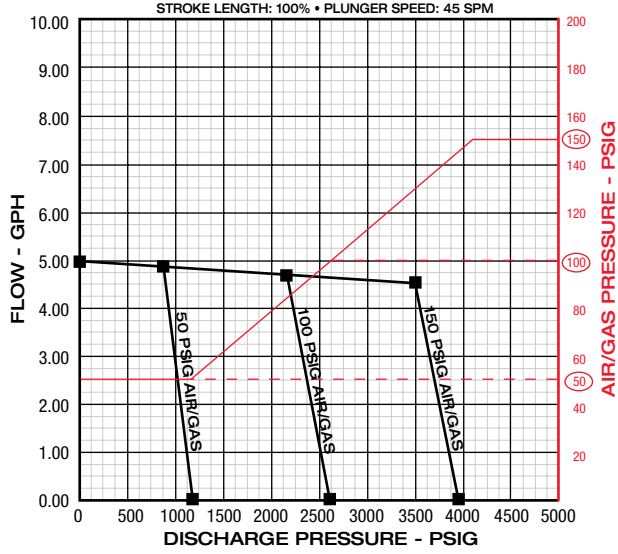

CRP750V400

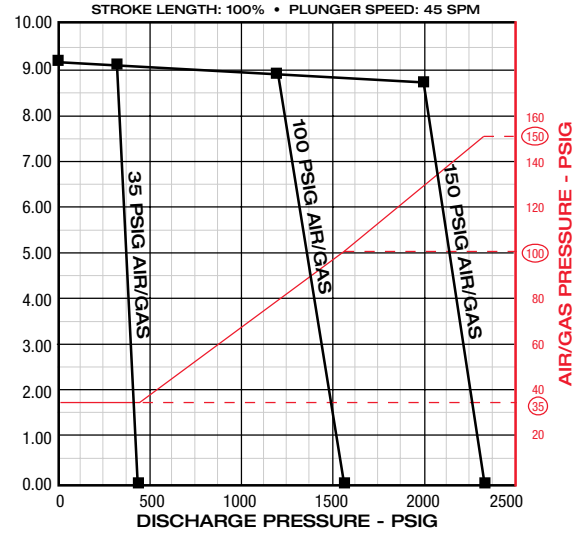

CRP1000V400

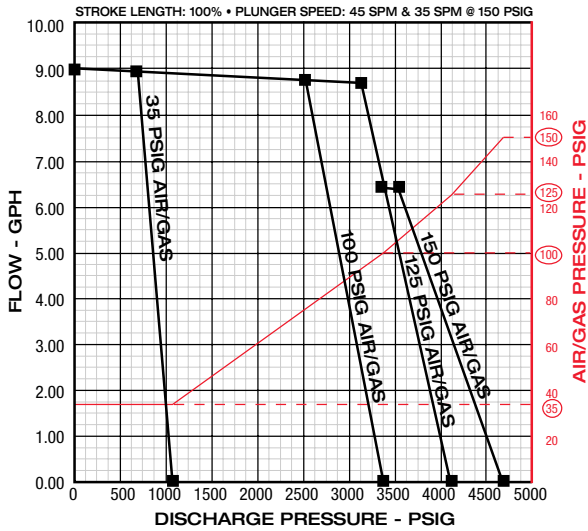

CRP1000V600

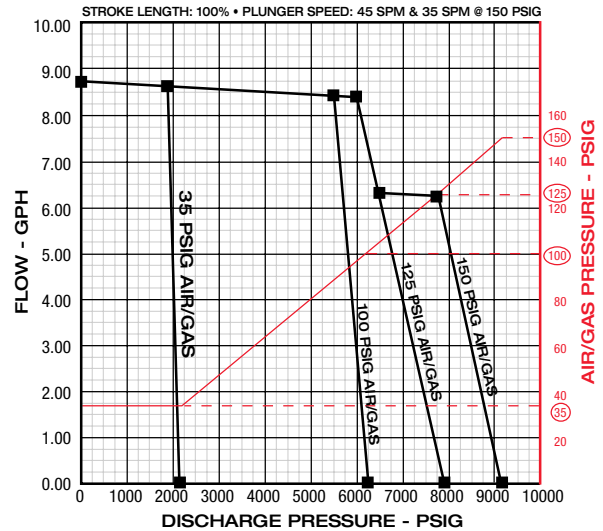

CRP1000V800

CONTROL METHODS FOR THE PUMP

MK XII OSCILLAMATIC® CONTROLLER

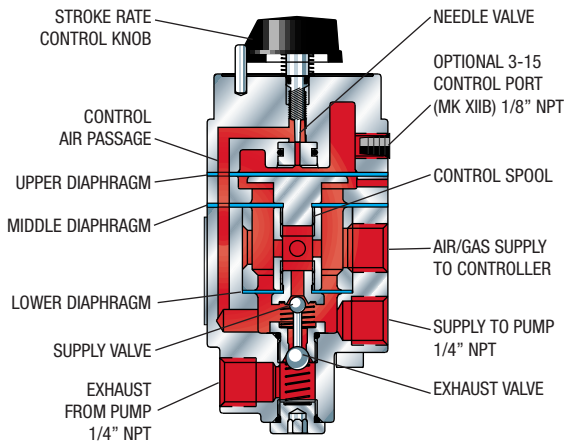

The MK XIIA Controller operates on the same operating principal as the MK X Controller. The MK XIIA has the same upper and lower chambers, but are separated with flexible diaphragms rather than sliding seals. A capillary tube, controlled by a needle valve, transfers the air/gas supply to the pump from the lower to the upper chamber.

When the spool is in the highest position, a pilot plug closes a vent and opens the supply air/gas to the pump. When the spool is in its lowest position, the pilot plug prevents the supply air/gas from entering the pump, and opens the air/gas vent to let it exhaust the pump. The spool then returns to its highest position to repeat the process.

CONTROLLER-PNEUMATIC RELAY COMBINATION

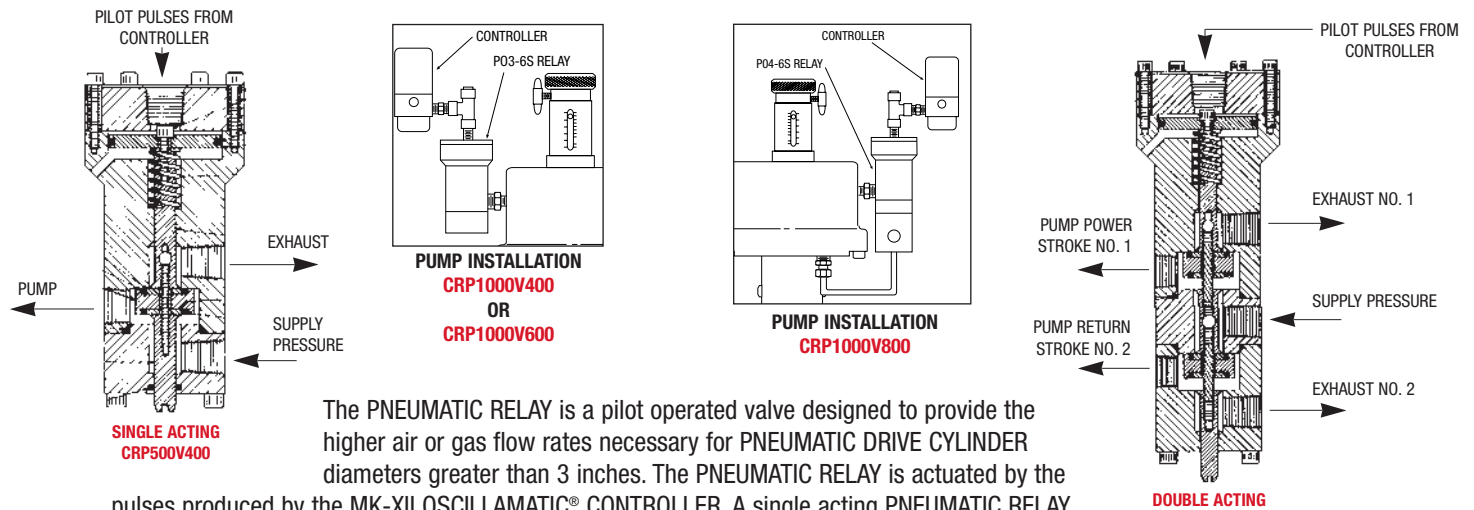

The PNEUMATIC RELAY is a pilot operated valve designed to provide the higher air or gas flow rates necessary for PNEUMATIC DRIVE CYLINDER diameters greater than 3 inches. The PNEUMATIC RELAY is actuated by the pulses produced by the MK-XII OSCILLAMATIC® CONTROLLER. A single acting PNEUMATIC RELAY is used with pumps that have return springs such as the CRP1000V400 and CRP1000V600. The air or gas pressure is required to return the PISTON-PLUNGER ASSEMBLY on the CRP1000V800. Therefore a double acting PNEUMATIC RELAY is required.

SOLENOID VALVES

The pumps can be automated by replacing the CONTROLLER with a 3-way electro-pneumatic SOLENOID VALVE. The SOLENOID VALVE can be cycled in order to achieve the desired pump output. Flow tracking can be accomplished by having a FLOWMETER or PH METER signal interpreted by our WPC9001 or a PLC. The typical arrangement for a WPC-9001 installation is shown at right.

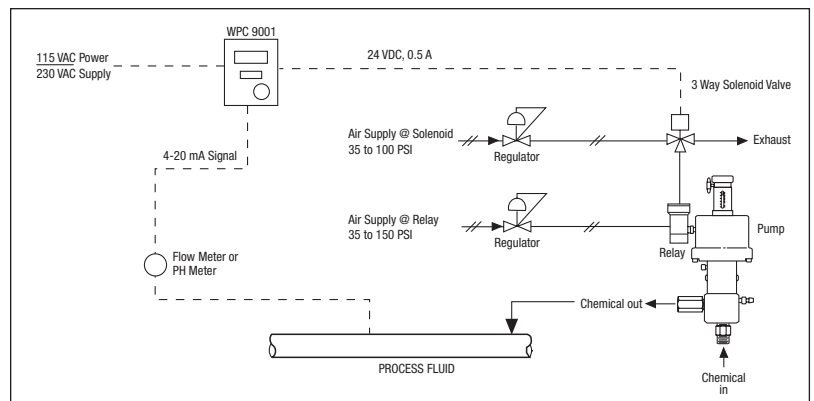

PLUNGER MATERIAL SELECTION

The materials available vary in hardness and chemical compatibility. We offer three materials based on our many years of industry experience with various chemicals. Hardness is a key property when selecting the proper plunger material. Our experience has shown that the harder plunger materials not only provide longer plunger life, they also provide greater seal life. A hard plunger is a must when pumping a chemical that is prone to crystallization or if the chemical is contaminated. Of course both of the above conditions will affect seal life. Below is a table that compares the chemical compatibility and hardness properties of each material.

DESIGNATION	MATERIAL	HARDNESS	CHEMICAL COMPATIBILITY
CR	Ceramic	Between Sapphire and Diamond on the Mohs' Scale	Excellent Chemical Inertness in all Acids, Bases, Solvents
A	17-4 ph	40 Rc	General Corrosion-resistant Stainless Steel Limited Acid Resistance
B	316 SS	28 Rc	Excellent Corrosion-resistant Stainless Steel Limited Acid Resistance

We recommend the use of ceramic because of its extreme hardness and excellent chemical inertness.

SEAL MATERIAL SELECTION

The seal material must be chosen to satisfy both the chemical compatibility and the pressures/temperatures at which you are operating. Below is a general guideline for seal material selection.

MATERIAL	SEAL TYPE	TEMP RANGE	SUGGESTED PRESSURE RANGE	COMMENTS
TG Teflon® Graphite	Mechanical (Spring Loaded)	-30 to 180°F -34 to 82°C	3000 to 10,000 psi 207 to 690 bar (High Pressure)	Tough material with excellent wear resistance. Excellent chemical inertness. Good for all types of chemicals, acids, bases or solvents. Recommended for use with the harder ceramic plunger and higher pressures.
TC Teflon® Composite	Mechanical (Spring Loaded)	-30 to 180°F -34 to 82°C	100 to 3000 psi 6.9 to 207 bar (Low Pressure)	Tough material with excellent wear resistance. Excellent chemical inertness. Good for all types of chemicals, acids, bases or solvents.
PE UHMW Polyethylene	Mechanical (Spring Loaded)	-30 to 180°F -34 to 82°C	100 to 3000 psi 6.9 to 207 bar	Tough material with excellent wear resistance. Good for water and alcohol based chemicals. Not recommended for solvents.
V Viton®	O-ring	-10 to 200°F -23 to 93°C	100 to 750 psi 6.9 to 52 bar	Soft material with fair wear resistance. Broad chemical compatibility but its not to be used with ethyl or methyl alcohols. Suggested only for hard to seal fluids in low pressure applications when PE or TC will not seal.
BR Buna N	O-ring	-40 to 200°F -40 to 93°C	100 to 750 psi 6.9 to 52 bar	Soft material with fair wear resistance. Limited chemical compatibility. Used mainly in Methanol pumping at low pressure.
K Kalrez®	O-ring	32 to 200°F 0 to 93°C	100 to 750 psi 6.9 to 52 bar	Soft material with fair wear resistance. Excellent chemical compatibility. Used when Viton® is not compatible and PE or TC will not seal.
EPR Ethylene Propylene	O-ring	-40 to 200°F -40 to 93°C	100 to 750 psi 6.9 to 52 bar	Material has very good abrasion resistance. Excellent chemical resistance to phosphate esters, good to excellent to mild acids, alkalis, silicone oils and greases, ketones and alcohols. Not recommended for petroleum oils or di-esters.

Selecting the proper seal material for your application is important. We suggest using the harder plastic seals (PE, TC or TG) whenever possible because they provide excellent wear life. The elastomers (V, BR, K or EPR) offer enhanced sealing at low pressure because they are soft and more compliant than the plastics. However, the elastomers do not provide the same toughness or wear resistance.

PART NUMBERING SYSTEM

C: Controller
 CR: Controller - Relay
 S: Solenoid Valve
 SR: Solenoid Valve - Relay

Control
 Method

CR P1000V800 A PE

Seal
 Material

PE: Polyethylene (UHMW)
 TC: Teflon® Composite
 TG: Teflon® Graphite
 V: Viton®
 BR: Buna N
 K: Kalrez®
 EPR: Ethylene Propylene

P125V125 P500V225 P750V400⁽¹⁾
 P250V225 P500V300 P1000V400⁽¹⁾
 P250V300 P500V400⁽¹⁾
 P1000V600⁽¹⁾
 P1000V800⁽¹⁾

Basic
 Model⁽²⁾

Plunger
 Material

A: 17-4 ph
 B: 316 SS
 CR: Ceramic

NOTE: ⁽¹⁾ The 400, 600 and 800 motor cylinders are only available with the CR (controller-relay) or SR (solenoid-relay) control methods.
⁽²⁾ An aluminum pneumatic section version of the pump can be specified by replacing the "V" with an "X". The "X" series is only available in the P125X, P250X, P500X and P750X models.

TYPICAL INSTALLATION

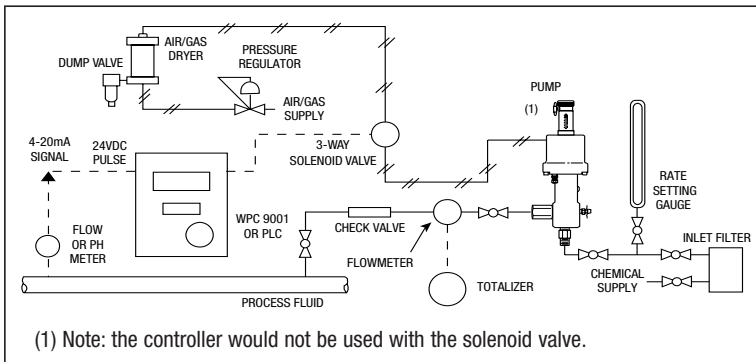

FlowTracking Controller Configuration

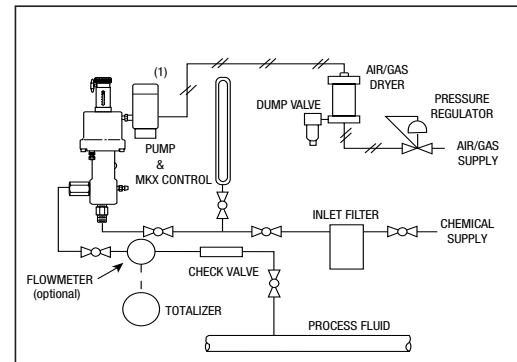

Standard Pneumatic Controller Configuration

DIMENSIONS & PHYSICAL SPECIFICATIONS

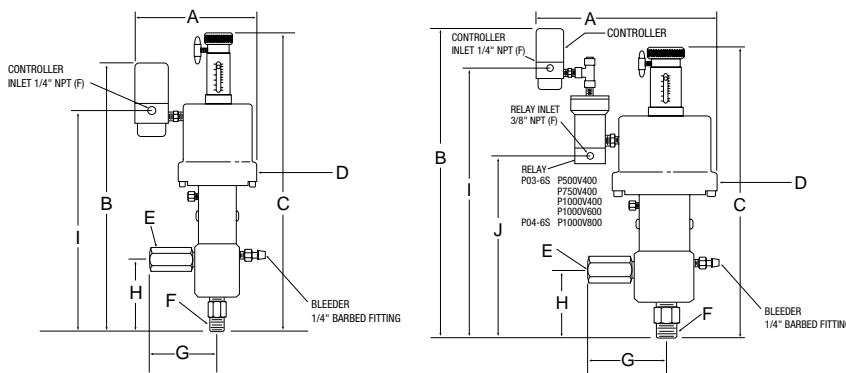

Model	Plunger Diameter (In.)	Piston Diameter (In.)
CP125V125	1/8	1 1/4
CP250V225	1/4	2 1/4
CP250V300	1/4	3
CP500V225	1/2	2 1/4
CP500V300	1/2	3
CRP500V400	1/2	4
CRP750V400	3/4	4
CRP1000V400	1	4
CRP1000V600	1	6
CRP1000V800	1	8

Model	A Inch/mm	B Inch/mm	C Inch/mm	D Diameter (IN)	E Connector	F Connector	G Inch/mm	H Inch/mm	I Inch/mm	J Inch/mm	WT LBS/KG
CP125V125	4.50/114.3	9.25/235	8.12/206.2	1 1/8" 47mm	1/4" NPT (F)	1/4" NPT (M)	1 3/4" 45mm	1 3/4" 45mm	6 1/4" 159mm	n/a	7.0/3.2
CP250V225	6.00/152.4	11.68/296.7	11.00/279.4	2 1/2" 63.5mm	1/4" NPT (F)	1/4" NPT (M)	2 9/16" 65mm	2 1/16" 68mm	8 7/8" 214mm	n/a	9.0/4.1
CP250V300	6.25/158.8	11.68/296.7	11.00/279.4	3 1/4" 82.5mm	1/4" NPT (F)	1/4" NPT (M)	2 9/16" 65mm	2 1/16" 68mm	8 7/8" 214mm	n/a	9.0/4.1
CP500V225	5.50/139.7	12.00/304.8	11.00/279.4	2 1/2" 63.5mm	1/4" NPT (F)	1/2" NPT (M)	2 5/8" 67mm	2 13/16" 69mm	8 9/16" 217mm	n/a	10.0/4.5
CP500V300	6.00/152.4	12.00/304.8	11.00/279.4	3 1/4" 82.5mm	1/4" NPT (F)	1/2" NPT (M)	2 5/8" 67mm	2 13/16" 69mm	8 9/16" 217mm	n/a	10.0/4.5
CRP500V400	9.12/232	16.00/406	11.00/279.4	4 1/4" 108mm	1/4" NPT (F)	1/2" NPT (M)	2 5/8" 67mm	2 13/16" 69mm	12 3/4" 324mm	9 7/16" 240mm	15.0/6.8
CRP750V400	9.75/247.6	16.25/412.7	11.31/287.2	4 9/16" 116mm	1/2" NPT (F)	3/4" NPT (M)	3 5/8" 92mm	3" 76.2mm	13" 331.7mm	7 9/16" 240mm	16.7/7.5
CRP1000V400	10.50/266.7	19.00/482.6	14.12/358.6	4 3/8" 111mm	1/2" NPT (F)	3/4" NPT (M)	4" 102mm	3 3/8" 86mm	14 5/8" 365mm	8 7/8" 225mm	29.0/13.2
CRP1000V600	12.50/317.5	19.00/482.6	14.12/358.6	6 3/8" 162mm	1/2" NPT (F)	3/4" NPT (M)	4" 102mm	3 3/8" 86mm	17 3/4" 451mm	12 1/4" 214mm	35.5/16.1
CRP1000V800	14.50/368.3	19.00/482.6	14.12/358.6	8 3/8" 213mm	1/2" NPT (F)	3/4" NPT (M)	4" 102mm	3 3/8" 86mm	16" 406mm	11" 279mm	47.6/21.6

“V” SERIES

The Williams “V” Series pneumatic metering pumps are engineered for **PERFORMANCE, QUALITY, SAFETY** and **SIMPLICITY**.

PERFORMANCE

- **ACCURACY** Our positive displacement plunger pumps can provide accuracies to $\pm 0.5\%$ satisfying **API-675**.
- **FLOW TURNDOWN** Since our metering pumps offer both stroke rate and stroke length adjustment, flow turndown ratios as great as 100:1 can be achieved exceeding the **API-675** requirement.
- **PRESSURE** Because of the large area difference between the air/gas piston and the plunger, our pumps can produce 10,000 PSI with only 100 PSI of air/gas supply pressure.
- **CORROSION RESISTANCE** We have selected materials, such as 316 SS, ceramic, elgiloy, TFE, etc., for both wetted and non wetted parts, that afford us the maximum corrosion resistance. These materials satisfy the requirements of such organizations as **NACE** and the **FDA**.



POWER GENERATION



PILOT PLANTS

QUALITY

- **TESTING** All pumps are performance tested prior to shipment.
- **RELIABILITY** Our quality assurance program insures the optimum in product performance and life by controlling the products configuration through all stages of design, engineering, production, assembly and test.
- **WARRANTY** We warrant both performance and manufacturing defects.



FOOD



PHARMACEUTICAL



CHEMICAL PROCESSING

SAFETY

- **PNEUMATICS** Unlike electrics, pneumatics provide an intrinsically safe design at no extra cost.
- **MATERIALS** The corrosion resistant materials used in the entire pump minimize the damage that could occur during a chemical spill.
- **LOCATION** Pneumatics and corrosion resistant materials allow our products to be used in harsh environments where wet/corrosive vapors or salt air is present.



OFFSHORE INDUSTRY



OIL PRODUCTION & REFINING

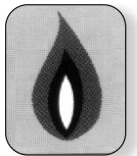

GAS PRODUCTION & PROCESSING

SIMPLICITY

- **SIZE** The pneumatic design concept provides a compact design much smaller than the comparable electrically driven pump.
- **INSTALLATION** The compact design allows the pumps to be installed directly in the piping with minimum support, thus eliminating the need for concrete pads.
- **MAINTENANCE** The pneumatic design approach limits the number of parts thus simplifying and minimizing maintenance.

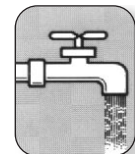

WATER TREATMENT



PULP & PAPER

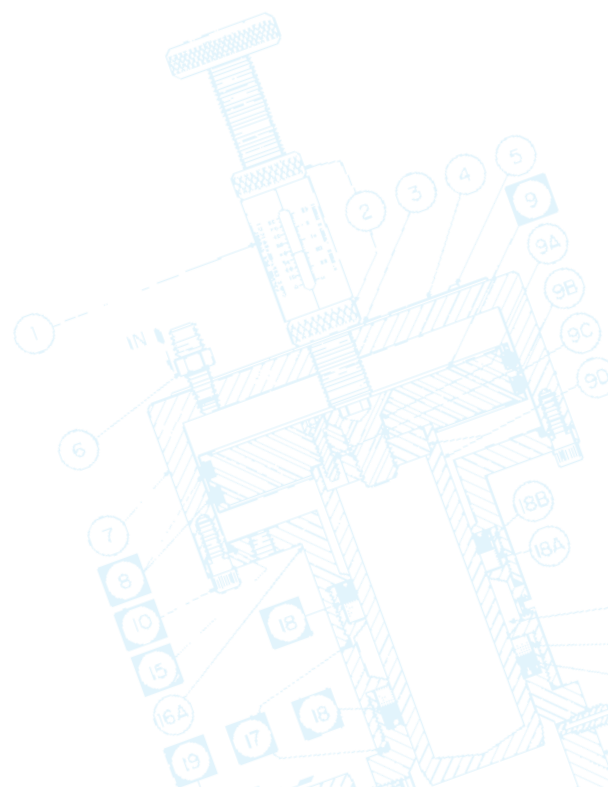

PUMP ACCESSORIES



WFS6704 Micro Flow Switch For Detecting Changes in Flow Rate

SENSITIVITY	OPERATING TEMP	OPERATING PRESSURE
0.1 PSI	-40° to +300° F	3000 PSI
0.689kPa	-40° to +150° C	207 Bar

AUTOMATIC DUMP VALVES Used with the Air or Gas Dryer-Filters

MODELS	BOWL	MAX. PRESSURE
ADV-150-A	Plastic	150 PSI
ADV-250-A	Steel	250 PSI



DRUM GAUGES ⁽²⁾ Liquid Level/Injection Rate Gauge

MODELS	MATERIALS
C779WS	Carbon Steel
C779WS-V	Carbon Steel - Vented
C779WS/SS	Stainless Steel
C779WS/SS-V	Stainless Steel - Vented
30216-CS-V-GPD-S	Carbon Steel
30216-S6-V-GPD-S	Stainless Steel

PCV125 AL Pressure Regulator

SENSITIVITY	FLOW RATES	MAX. PRESSURE
0.1 PSI	20SCFM	250 PSI
0.689kPa	.566m3/min	1724 kPa



LIQUID CHEMICAL FILTERS ⁽¹⁾ 316 Stainless Steel

MODELS	CONNECTION FILTER ELEMENT	OPTIONAL FILTER ELEMENT
LCF10-25	1/4" NPT 25 micron, Std	1, 2, 8 microns or 100 mesh stainless steel screen
LCF15-25	1/2" NPT 25 micron, Std	

AIR OR GAS DRYER-FILTERS Complete with Manual Drain Valve

MODELS	FLOW RATES	MAX. PRESSURE
J150	40SCFM	150 PSI
J500	40SCFM	500 PSI



APU-XP Automatic Processing Unit

FREQUENCY	ACCURACY
0-45 SPM	± 0.25% of span

WPC9001 Electronic Pump Controller

MODEL	NEMA CLASS	MAX. TEMP.	OPERATING MODES
WPC9001-GP	4X	140° F	Auto
WPC9001-XP	7	60° C	Manual Switching



NOTES: ⁽¹⁾ Use only with all models of P125V, P250V and P500V pumps.

⁽²⁾ Use the C779 with all models of P125V, P250V and P500V; use the 30216 with all models of P750V and P1000V.



WILLIAMS
INSTRUMENT INCORPORATED

MILTON ROY
A Sundstrand Company

NOVATEC
FLUID SYSTEMS S.A.

SOLUCIONES CONFIABLES
Sistemas y equipos para el manejo, control, dosificación y agitación de fluidos.

CALI • COLOMBIA
Calle 69 No. 7D Bis-15 - PBX: (57-2) 418-4006 - FAX: (57-2) 656 0052 / 6631997

BOGOTÁ D.C. • COLOMBIA
Cra. 14 No. 76-25 Edificio Centro Ejecutivo 76 01. 501 - PBX: (57-1) 743 2303

www.novatecs.com

PENNSYLVANIA: 201 Ivyland Road • Ivyland, PA 18974 • TEL: (800) 235-3421 • (215) 293-0415 • FAX: (215) 293-0498 • E-mail: info@williamspumps.com

CANADA: 9357 45th Avenue • Edmonton, Alberta T6E 5Z7 • TEL: (780) 434-9471 • FAX: (780) 435-6560 • E-mail: edmonton@williamspumps.com

SINGAPORE: 18 Bedok Road South • Singapore 469276 • TEL: (65) 242-9182 • FAX: (65) 243-4249 • E-mail: singapore@williamspumps.com

www.williamspumps.com

V BROCHURE Revised 6-99